

Contents

1. SAFETY PRECAUTIONS.....	1
2. PRODUCT SPECIFICATION	3
2.1. Installation tools	3
2.2. Accessories	4
2.3. Pipe requirements	4
2.4. Electrical requirements	5
2.5. Additional charge amount	6
2.6. General information	6
3. INSTALLATION WORK	6
3.1. Installation dimensions	6
3.2. Mounting the unit	7
3.3. Removing and replacing part.....	8
3.4. Drain installation	8
3.5. Pipe installation	8
3.6. Sealing test	9
3.7. Vacuum process	9
3.8. Additional charging	10
3.9. Electrical wiring	10
4. HOW TO OPERATE DISPLAY UNIT.....	12
4.1. Various setting methods	12
4.2. Outdoor unit low noise operation function (option)	13
4.3. Changing the current limit function	13
5. CHECK RUN	13
5.1. Things to confirm before starting the check run.....	13
5.2. Restrictions applicable when performing the check run	13
5.3. Operating procedure for check run	14
5.4. Check run judgment failure display	16
5.5. Re-display check run results	16
5.6. Automatic wiring correction memory reset.....	16
6. TEST RUN.....	16
6.1. TEST RUN method.....	16
7. ERROR CODE	17
7.1. In the event of an error	17
7.2. Error location display	17
7.3. Error code display.....	17
8. PUMP DOWN.....	17
9. FINISHING	18
9.1. Installing insulation	18
10. CUSTOMER GUIDANCE	18

1. SAFETY PRECAUTIONS

- Be sure to read this manual thoroughly before installation.
- The warnings and precautions indicated in this manual contain important information pertaining to your safety. Be sure to observe them.
- Hand this manual, together with the operation manual, to the customer. Request the customer to keep them on hand for future use, such as for relocating or repairing the unit.

⚠ WARNING

Indicates a potentially or imminently hazardous situation which, if not avoided, could result in death or serious injury.

⚠ CAUTION

Indicates a potentially hazardous situation that may result in minor or moderate injury or damage to property.

⚠ WARNING

- Installation of this product must be done by experienced service technicians or professional installers only in accordance with this manual. Installation by nonprofessional or improper installation of the product may cause serious accidents such as injury, water leakage, electric shock, or fire. If the product is installed in disregard of the instructions in this manual, it will void the manufacturer's warranty.
- To avoid getting an electric shock, never touch the electrical components soon after the power supply has been turned off. After turning off the power, always wait 10 minutes or more before you touch the electrical components.
- Do not turn on the power until all work has been completed. Turning on the power before the work is completed can cause serious accidents such as electric shock or fire.
- If refrigerant leaks while work is being carried out, ventilate the area. If the refrigerant comes in contact with a flame, it produces a toxic gas.
- Installation must be performed in accordance with regulations, codes, or standards for electrical wiring and equipment in each country, region, or the installation place.
- Do not use this equipment with air or any other unspecified refrigerant in the refrigerant lines. Excess pressure can cause a rupture.
- During installation, make sure that the refrigerant pipe is attached firmly before you run the compressor.
- Do not operate the compressor under the condition of refrigerant piping not attached properly with 3-way valve open. This may cause abnormal pressure in the refrigeration cycle that leads to rupture and even injury.
- When installing or relocating the air conditioner, do not mix gases other than the specified refrigerant (R32) to enter the refrigerant cycle.
- If air or other gas enters the refrigerant cycle, the pressure inside the cycle will rise to an abnormally high value and cause rupture, injury, etc.
- To connect the indoor unit and outdoor unit, use air conditioner piping and cables available locally as standard parts. This manual describes proper connections using such installation set.
- Do not modify power cable, use extension cable or branch wiring. Improper use may cause electric shock or fire by poor connection, insufficient insulation or over current.
- Do not purge the air with refrigerants but use a vacuum pump to vacuum the installation.
- There is not extra refrigerant in the outdoor unit for air purging.
- Use a vacuum pump for R32 or R410A exclusively.
- Use the same vacuum pump for different refrigerants may damage the vacuum pump or the unit.
- Use a clean gauge manifold and charging hose for R32 or R410A exclusively.
- Do not use means to accelerate the defrosting process or to clean, other than those recommended by the manufacturer.
- The appliance shall be stored in a room without continuously operating ignition sources (for example: open flames, an operating gas appliance or an operating electric heater).
- Do not pierce or burn.
- Be aware that refrigerants may not contain an odour.
- During the pump-down operation, make sure that the compressor is turned off before you remove the refrigerant piping.
- Do not remove the connection pipe while the compressor is in operation with 3-way valve open.
- This may cause abnormal pressure in the refrigeration cycle that leads to rupture and even injury.
- This appliance is not intended for use by persons (including children) with reduced physical, sensory or mental capabilities, or lack of experience and knowledge, unless they have been given supervision or instruction concerning use of the appliance by a person responsible for their safety. Children should be supervised to ensure that they do not play with the appliance.

⚠ CAUTION

- For the air conditioner to work appropriately, install it as written in this manual.
- This product must be installed by qualified personnel with a capacity certification of handling refrigerant fluids. Refer to regulation and laws in use on installation place.
- Install the product by following local codes and regulations in force at the place of installation, and the instructions provided by the manufacturer.
- This product is part of a set constituting an air conditioner. The product must not be installed alone or be installed with non-authorized device by the manufacturer.
- Always use a separate power supply line protected by a circuit breaker operating on all wires with a distance between contact of 3 mm for this product.
- To protect the persons, ground (earth) the product correctly, and use the power cable combined with an Earth Leakage Circuit Breaker (ELCB).
- This product is not explosion proof, and therefore should not be installed in explosive atmosphere.
- This product contains no user-serviceable parts. Always consult experienced service technicians for repairing.
- When moving or relocating the air conditioner, consult experienced service technicians for disconnection and reinstallation of the product.
- Do not touch the fins of the heat exchanger. Touching the heat exchanger fins could result in damage to the fins or personal injury such as skin rupture.

Precautions for using R32 refrigerant

The basic installation work procedures are the same as conventional refrigerant (R410A, R22) models.

However, pay careful attention to the following points:

WARNING

- Since the working pressure is 1.6 times higher than that of refrigerant R22 models, some of the piping and installation and service tools are special. (Refer to "2.1. Installation tools".)
Especially, when replacing a refrigerant R22 model with a new refrigerant R32 model, always replace the conventional piping and flare nuts with the R32 and R410A piping and flare nuts on the outdoor unit side.
For R32 and R410A, the same flare nut on the outdoor unit side and pipe can be used.
- Models that use refrigerant R32 and R410A have a different charging port thread diameter to prevent erroneous charging with refrigerant R22 and for safety. Therefore, check beforehand. [The charging port thread diameter for R32 and R410A is 1/2 inch.]
- Be more careful than R22 so that foreign matter (oil, water, etc.) does not enter the piping.
Also, when storing the piping, securely seal the opening by pinching, taping, etc. (Handling of R32 is similar to R410A.)

CAUTION

1. Installation (Space)

- That the installation of pipe-work shall be kept to a minimum.
- That pipe-work shall be protected from physical damage.
- That compliance with national gas regulations shall be observed.
- That mechanical connections shall be accessible for maintenance purposes.
- In cases that require mechanical ventilation, ventilation openings shall be kept clear of obstruction.
- When disposing of the product is used, be based on national regulations, properly processed.

2. Servicing

2-1. Service personnel

- Any person who is involved with working on or breaking into a refrigerant circuit should hold a current valid certificate from an industry-accredited assessment authority, which authorizes their competence to handle refrigerants safely in accordance with an industry recognised assessment specification.
- Servicing shall only be performed as recommended by the equipment manufacturer. Maintenance and repair requiring the assistance of other skilled personnel shall be carried out under the supervision of the person competent in the use of flammable refrigerants.
- Servicing shall be performed only as recommended by the manufacturer.

2-2. Work

- Prior to beginning work on systems containing flammable refrigerants, safety checks are necessary to ensure that the risk of ignition is minimised. For repair to the refrigerating system, the precautions in 2-2 to 2-8 shall be complied with prior to conducting work on the system.
- Work shall be undertaken under a controlled procedure so as to minimize the risk of a flammable gas or vapour being present while the work is being performed.
- All maintenance staff and others working in the local area shall be instructed on the nature of work being carried out.
- Work in confined spaces shall be avoided.
- The area around the workspace shall be sectioned off.
- Ensure that the conditions within the area have been made safe by control of flammable material.

2-3. Checking for presence of refrigerant

- The area shall be checked with an appropriate refrigerant detector prior to and during work, to ensure the technician is aware of potentially flammable atmospheres.
- Ensure that the leak detection equipment being used is suitable for use with flammable refrigerants, i.e. non sparking, adequately sealed or intrinsically safe.

2-4. Presence of fire extinguisher

- If any hot work is to be conducted on the refrigeration equipment or any associated parts, appropriate fire extinguishing equipment shall be available at hand.
- Have a dry powder or CO₂ fire extinguisher adjacent to the charging area.

2-5. No ignition sources

- No person carrying out work in relation to a refrigeration system which involves exposing any pipe work that contains or has contained flammable refrigerant shall use any sources of ignition in such a manner that it may lead to the risk of fire or explosion.
- All possible ignition sources, including cigarette smoking, should be kept sufficiently far away from the site of installation, repairing, removing and disposal, during which flammable refrigerant can possibly be released to the surrounding space.
- Prior to work taking place, the area around the equipment is to be surveyed to make sure that there are no flammable hazards or ignition risks. "No Smoking" signs shall be displayed.

2-6. Ventilated area

- Ensure that the area is in the open or that it is adequately ventilated before breaking into the system or conducting any hot work.
- A degree of ventilation shall continue during the period that the work is carried out.
- The ventilation should safely disperse any released refrigerant and preferably expel it externally into the atmosphere.

2-7. Checks to the refrigeration equipment

- Where electrical components are being changed, they shall be fit for the purpose and to the correct specification.
- At all times the manufacturer's maintenance and service guidelines shall be followed.
- If in doubt consult the manufacturer's technical department for assistance.
- The following checks shall be applied to installations using flammable refrigerants.
 - The charge size is in accordance with the room size within which the refrigerant containing parts are installed.
 - The ventilation machinery and outlets are operating adequately and are not obstructed.
 - If an indirect refrigerating circuit is being used, the secondary circuit shall be checked for the presence of refrigerant.
 - Marking to the equipment continues to be visible and legible. Markings and signs that are illegible shall be corrected.
 - Refrigeration pipe or components are installed in a position where they are unlikely to be exposed to any substance which may corrode refrigerant containing components, unless the components are constructed of materials which are inherently resistant to being corroded or are suitably protected against being so corroded.

2-8. Checks to electrical devices

- Repair and maintenance to electrical components shall include initial safety checks and component inspection procedures.
- If a fault exists that could compromise safety, then no electrical supply shall be connected to the circuit until it is satisfactorily dealt with.
- If the fault cannot be corrected immediately but it is necessary to continue operation, an adequate temporary solution shall be used.
- This shall be reported to the owner of the equipment so all parties are advised.
- Initial safety checks shall include.
 - That capacitors are discharged: this shall be done in a safe manner to avoid possibility of sparking.
 - That there no live electrical components and wiring are exposed while charging, recovering or purging the system.
 - That there is continuity of earth bonding.

3. Repairs to sealed components

- During repairs to sealed components, all electrical supplies shall be disconnected from the equipment being worked upon prior to any removal of sealed covers, etc.
 - If it is absolutely necessary to have an electrical supply to equipment during servicing, then a permanently operating form of leak detection shall be located at the most critical point to warn of a potentially hazardous situation.
 - Particular attention shall be paid to the following to ensure that by working on electrical components, the casing is not altered in such a way that the level of protection is affected.
 - This shall include damage to cables, excessive number of connections, terminals not made to original specification, damage to seals, incorrect fitting of glands, etc.
 - Ensure that apparatus is mounted securely.
 - Ensure that seals or sealing materials have not degraded such that they no longer serve the purpose of preventing the ingress of flammable atmospheres.
 - Replacement parts shall be in accordance with the manufacturer's specifications.
- NOTE: The use of silicon sealant may inhibit the effectiveness of some types of leak detection equipment.
Intrinsically safe components do not have to be isolated prior to working on them.

4. Repair to intrinsically safe components

- Do not apply any permanent inductive or capacitance loads to the circuit without ensuring that this will not exceed the permissible voltage and current permitted for the equipment in use.
- Intrinsically safe components are the only types that can be worked on while live in the presence of a flammable atmosphere.
- The test apparatus shall be at the correct rating.
- Replace components only with parts specified by the manufacturer.
- Other parts may result in the ignition of refrigerant in the atmosphere from a leak.

5. Cabling

- Check that cabling will not be subject to wear, corrosion, excessive pressure, vibration, sharp edges or any other adverse environmental effects.
- The check shall also take into account the effects of aging or continual vibration from sources such as compressors or fans.

6. Detection of flammable refrigerants

- Under no circumstances shall potential sources of ignition be used in the searching for or detection of refrigerant leaks.
- A halide torch (or any other detector using a naked flame) shall not be used.

7. Leak detection methods

- Electronic leak detectors shall be used to detect flammable refrigerants, but the sensitivity may not be adequate, or may need re-calibration. (Detection equipment shall be calibrated in a refrigerant-free area.)
- Ensure that the detector is not a potential source of ignition and is suitable for the refrigerant used.
- Leak detection equipment shall be set at a percentage of the LFL of the refrigerant and shall be calibrated to the refrigerant employed and the appropriate percentage of gas (25 % maximum) is confirmed.
- Leak detection fluids are suitable for use with most refrigerants but the use of detergents containing chlorine shall be avoided as the chlorine may react with the refrigerant and corrode the copper pipe-work.
- If a leak is suspected, all naked flames shall be removed/extinguished.
- If a leakage of refrigerant is found which requires brazing, all of the refrigerant shall be recovered from the system, or isolated (by means of shut off valves) in a part of the system remote from the leak.
Oxygen free nitrogen (OFN) shall then be purged through the system both before and during the brazing process.

⚠ CAUTION

8. Removal and evacuation

- When breaking into the refrigerant circuit to make repairs – or for any other purpose –conventional procedures shall be used. However, it is important that best practice is followed since flammability is a consideration. The following procedure shall be adhered to:
 - remove refrigerant
 - purge the circuit with inert gas
 - evacuate
 - purge again with inert gas
 - open the circuit by cutting or brazing
- The refrigerant charge shall be recovered into the correct recovery cylinders.
- The system shall be "flushed" with OFN to render the unit safe.
- This process may need to be repeated several times.
- Compressed air or oxygen shall not be used for this task.
- Flushing shall be achieved by breaking the vacuum in the system with OFN and continuing to fill until the working pressure is achieved, then venting to atmosphere, and finally pulling down to a vacuum.
- This process shall be repeated until no refrigerant is within the system.
- When the final OFN charge is used, the system shall be vented down to atmospheric pressure to enable work to take place.
- This operation is absolutely vital if brazing operations on the pipe work are to take place.
- Ensure that the outlet for the vacuum pump is not close to any ignition sources and there is ventilation available.

9. Charging procedures

- In addition to conventional charging procedures, the following requirements shall be followed.
 - Ensure that contamination of different refrigerants does not occur when using charging equipment.
 - Hoses or lines shall be as short as possible to minimize the amount of refrigerant contained in them.
 - Cylinders shall be kept upright.
 - Ensure that the refrigeration system is earthed prior to charging the system with refrigerant.
 - Label the system when charging is complete (if not already).
 - Extreme care shall be taken not to overfill the refrigeration system.
- Prior to recharging the system it shall be pressure tested with OFN.
- The system shall be leak tested on completion of charging but prior to commissioning.
- A follow up leak test shall be carried out prior to leaving the site.

10. Decommissioning

- Before carrying out this procedure, it is essential that the technician is completely familiar with the equipment and all its details.
- It is recommended good practice that all refrigerants are recovered safely.
- Prior to the task being carried out, an oil and refrigerant sample shall be taken in case analysis is required prior to reuse of reclaimed refrigerant.
- It is essential that electrical power is available before the task is commenced.
 - Become familiar with the equipment and its operation.
 - Isolate system electrically.
 - Before attempting the procedure ensure that:
 - mechanical handling equipment is available, if required, for handling refrigerant cylinders;
 - all personal protective equipment is available and being used correctly;
 - the recovery process is supervised at all times by a competent person;
 - recovery equipment and cylinders conform to the appropriate standards.
 - Pump down refrigerant system, if possible.
 - If a vacuum is not possible, make a manifold so that refrigerant can be removed from various parts of the system.
 - Make sure that cylinder is situated on the scales before recovery takes place.
 - Start the recovery machine and operate in accordance with manufacturer's instructions.
 - Do not overfill cylinders. (No more than 80 % volume liquid charge).
 - Do not exceed the maximum working pressure of the cylinder, even temporarily.
 - When the cylinders have been filled correctly and the process completed, make sure that the cylinders and the equipment are removed from site promptly and all isolation valves on the equipment are closed off.
 - Recovered refrigerant shall not be charged into another refrigeration system unless it has been cleaned and checked.





11. Labelling

- Equipment shall be labelled stating that it has been de-commissioned and emptied of refrigerant.
- The label shall be dated and signed.
- Ensure that there are labels on the equipment stating the equipment contains flammable refrigerant.

12. Recovery

- When removing refrigerant from a system, either for servicing or decommissioning, it is recommended good practice that all refrigerants are removed safely.
- When transferring refrigerant into cylinders, ensure that only appropriate refrigerant recovery cylinders are employed.
- Ensure that the correct number of cylinders for holding the total system charge are available.
- All cylinders to be used are designated for the recovered refrigerant and labelled for that refrigerant (i.e. special cylinders for the recovery of refrigerant).
- Cylinders shall be complete with pressure relief valve and associated shut-off valves in good working order.
- Empty recovery cylinders are evacuated and, if possible, cooled before recovery occurs.
- The recovery equipment shall be in good working order with a set of instructions concerning the equipment that is at hand and shall be suitable for the recovery of flammable refrigerants.
- In addition, a set of calibrated weighing scales shall be available and in good working order.
- Hoses shall be complete with leak-free disconnect couplings and in good condition.
- Before using the recovery machine, check that it is in satisfactory working order, has been properly maintained and that any associated electrical components are sealed to prevent ignition in the event of a refrigerant release. Consult manufacturer if in doubt.
- The recovered refrigerant shall be returned to the refrigerant supplier in the correct recovery cylinder, and the relevant Waste Transfer Note arranged.
- Do not mix refrigerants in recovery units and especially not in cylinders.
- If compressors or compressor oils are to be removed, ensure that they have been evacuated to an acceptable level to make certain that flammable refrigerant does not remain within the lubricant.
- The evacuation process shall be carried out prior to returning the compressor to the suppliers.
- Only electric heating to the compressor body shall be employed to accelerate this process.
- When oil is drained from a system, it shall be carried out safely.

Explanation of symbols displayed on the indoor unit or outdoor unit.

	WARNING	This symbol shows that this equipment uses a flammable refrigerant. If the refrigerant is leaked, together with an external ignition source, there is a possibility of ignition.
	CAUTION	This symbol shows that the Operation Manual should be read carefully.
	CAUTION	This symbol shows that a service personnel should be handling this equipment with reference to the Installation Manual.
	CAUTION	This symbol shows that there is information included in the Operation Manual and/or Installation Manual.

2. PRODUCT SPECIFICATION

2.1. Installation tools

⚠ WARNING

- To install a unit that uses R32 refrigerant, use dedicated tools and piping materials that have been manufactured specifically for R32(R410A) use. Because the pressure of R32 refrigerant is approximately 1.6 times higher than R22, failure to use dedicated piping material or improper installation can cause rupture or injury. Furthermore, it can cause serious accidents such as water leakage, electric shock, or fire.
- Do not use a vacuum pump or refrigerant recovery tools with a series motor, since it may ignite.

Tool name	Contents of change
Gauge manifold	Pressure is high and cannot be measured with a conventional (R22) gauge. To prevent erroneous mixing of other refrigerants, the diameter of each port has been changed. It is recommended the gauge with seals -0.1 to 5.3 MPa (-1 to 53 bar) for high pressure. -0.1 to 3.8 MPa (-1 to 38 bar) for low pressure.
Charge hose	To increase pressure resistance, the hose material and base size were changed. (R32/R410A)
Vacuum pump	A conventional vacuum pump can be used by installing a vacuum pump adapter. (Use of a vacuum pump with a series motor is prohibited.)
Gas leakage detector	Special gas leakage detector for HFC refrigerant R32/R410A.



■ Copper pipes

It is necessary to use seamless copper pipes and it is desirable that the amount of residual oil is less than 40 mg/10 m. Do not use copper pipes having a collapsed, deformed or discolored portion (especially on the interior surface). Otherwise, the expansion valve or capillary tube may become blocked with contaminants. As an air conditioner using R32(R410A) incurs pressure higher than when using conventional refrigerant, it is necessary to choose adequate materials.

2.2. Accessories

⚠ WARNING

- For installation purposes, be sure to use the parts supplied by the manufacturer or other prescribed parts. The use of non-prescribed parts can cause serious accidents such as the unit falling, water leakage, electric shock, or fire.
- The following installation parts are supplied. Use them as required.
- Keep the Installation Manual in a safe place and do not discard any other accessories until the installation work has been completed.

Name and shape	Q'ty	Description
Installation Manual 	1	This manual
Drain pipe 	1	For outdoor unit drain piping work [Heat & Cool model (Reverse cycle) only]
Adapter K: [mm (in.)] [12.70 (1/2) → 9.52 (3/8)] 	24 model 1	An adapter may be required to connect the indoor unit. For more information, refer to the installation manual included with the indoor unit.

2.3. Pipe requirements

⚠ CAUTION

- Do not use existing pipes.
- Use pipes that have clean external and internal sides without any contamination which may cause trouble during use, such as sulfur, oxide, dust, cutting waste, oil, or water.
- It is necessary to use seamless copper pipes.
Material: Phosphor deoxidized seamless copper pipes.
It is desirable that the amount of residual oil is less than 40 mg/10 m.
- Do not use copper pipes that have a collapsed, deformed, or discolored portion (especially on the interior surface). Otherwise, the expansion valve or capillary tube may become blocked with contaminants.
- Improper pipe selection will degrade performance. As an air conditioner using R32(R410A) incurs pressure higher than when using conventional refrigerant, it is necessary to choose adequate materials.

- Thicknesses of copper pipes used with R32(R410A) are as shown in the table.
- Never use copper pipes thinner than those indicated in the table even if they are available on the market.

Thicknesses of Annealed Copper Pipes

Pipe outside diameter [mm (in.)]	Thickness [mm]
6.35 (1/4)	0.80
9.52 (3/8)	0.80
12.70 (1/2)	0.80
15.88 (5/8)	1.00
19.05 (3/4)	1.20

■ Protection of pipes

- Protect the pipes to prevent the entry of moisture and dust.
- Especially, pay attention when passing the pipes through a hole or connecting the end of a pipe to the outdoor unit.

Location	Working period	Protection method
Outdoor	1 month or more	Pinch pipes
	Less than 1 month	Pinch or tape pipes
Indoor	-	Pinch or tape pipes

■ Refrigerant pipe size and allowable piping length

⚠ CAUTION

- Keep the piping length between the indoor unit and outdoor unit within the allowable tolerance.
- The maximum lengths of this product are shown in the table. If the units are further apart than this, correct operation cannot be guaranteed.
- When installing pipes shorter than 3 m, sound of the outdoor unit may be transferred to the indoor unit, which may cause large operating sound or some abnormal sound.

Layout example for the indoor units and outdoor unit

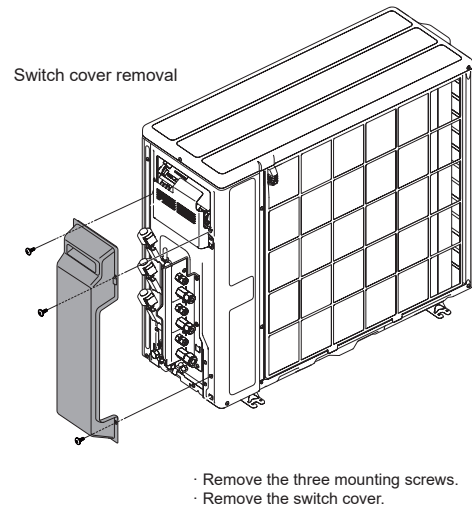

- Remove the three mounting screws.
- Remove the switch cover.

2.3.1. Connectable indoor unit capacity type (Outdoor unit: 24 model)

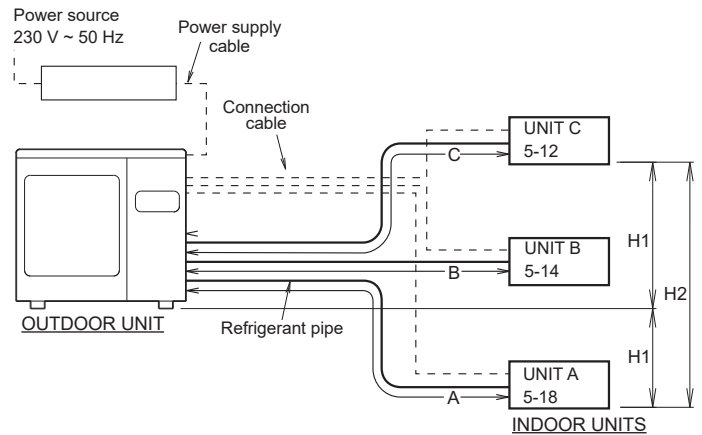

⚠ CAUTION

- The total capacity of the indoor units connected must be between 14,000 and 36,000 BTU.
- Connection patterns are restricted. Normal operation is not guaranteed if connected pattern in the combination not listed below. The product may be damaged. Surely connect in accordance with the combination in the following connection pattern.
- When connecting a wall-mounted type of KN Series, connect it to an outdoor unit model with a serial number E100001 or later.

- To install an indoor unit, refer to the installation manual included with the indoor unit.

	Outdoor port	Capacity indoor unit
	Standard port size [mm (in.)]	
C	6.35 (1/4) / 9.52 (3/8)	5 - 12
B	6.35 (1/4) / 9.52 (3/8)	5 - 14
A	6.35 (1/4) / 12.70 (1/2)	5 - 18

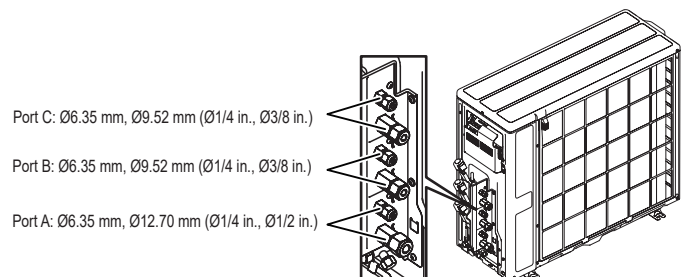

2.3.2. Connectable indoor unit capacity type (Outdoor unit: 18 model)

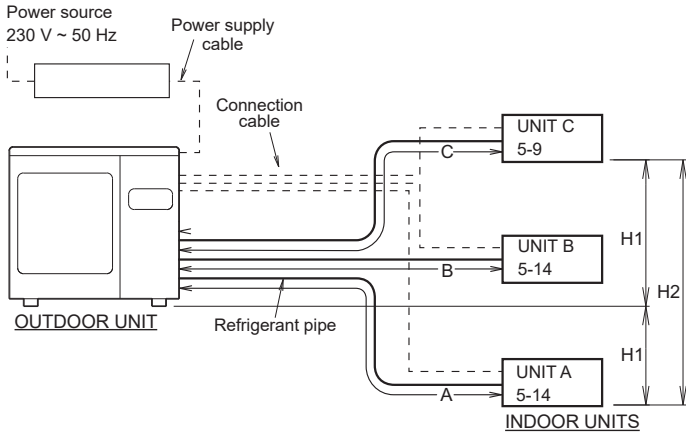

CAUTION

- The total capacity of the indoor units connected must be between 14,000 and 30,000 BTU.
- Connection patterns are restricted. Normal operation is not guaranteed if connected pattern in the combination not listed below. The product may be damaged. Surely connect in accordance with the combination in the following connection pattern.
- When connecting a wall-mounted type of KN Series, connect it to an outdoor unit model with a serial number E100001 or later.

- To install an indoor unit, refer to the installation manual included with the indoor unit.

Outdoor port		Capacity indoor unit
Standard port size [mm (in.)]		
C	6.35 (1/4) / 9.52 (3/8)	5 - 9
B	6.35 (1/4) / 9.52 (3/8)	5 - 14
A	6.35 (1/4) / 9.52 (3/8)	5 - 14

Port C: $\varnothing 6.35$ mm, $\varnothing 9.52$ mm ($\varnothing 1/4$ in., $\varnothing 3/8$ in.)

Port B: $\varnothing 6.35$ mm, $\varnothing 9.52$ mm ($\varnothing 1/4$ in., $\varnothing 3/8$ in.)

Port A: $\varnothing 6.35$ mm, $\varnothing 9.52$ mm ($\varnothing 1/4$ in., $\varnothing 3/8$ in.)

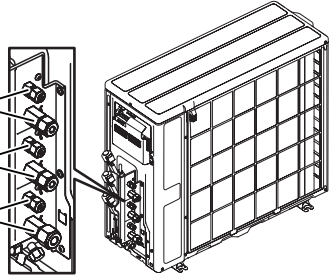

Limitation of refrigerant piping length

CAUTION

- The total maximum pipe lengths and height difference of this product are shown in the table.
- If the units are further apart than this, correct operation cannot be guaranteed.

Total max. length (a+b+c)	50 m ¹
Max. length for each indoor unit (a, b, or c)	25 m
Max. height difference between outdoor unit and each indoor unit (H1)	15 m
Max. height difference between indoor units (H2)	10 m
Min. length for each indoor unit (a, b, or c)	2.5 m
Total min. length (a+b)	10 m

¹ If the total piping length is longer than 20 m, additional refrigerant charging is necessary. (For more information, refer to "3.8. Additional charging".)

Selecting pipe sizes

The diameters of the connection pipes differ according to the capacity of the indoor unit. Refer to the following table for the proper diameters of the connection pipes between the indoor and outdoor units.

Capacity of indoor unit	Gas pipe size (thickness) mm (mm)	Liquid pipe size (thickness) mm (mm)
5, 7, 9, 12, 14 model	$\varnothing 9.52$ (0.8)	$\varnothing 6.35$ (0.8)
18 model	$\varnothing 12.70$ (0.8)	$\varnothing 6.35$ (0.8)

CAUTION

- Operation cannot be guaranteed if the correct combination of pipes, valves, etc., is not used to connect the indoor and outdoor units.

Heat insulation around connection pipes requirements

CAUTION

- Install heat insulation around both the gas and liquid pipes. Failure to do so may cause water leaks.
- Use heat insulation with heat resistance above 120 °C. (Reverse cycle model only)
- In addition, if the humidity level at the installation location of the refrigerant piping is expected to exceed 70%, install heat insulation around the refrigerant piping. If the expected humidity level is 70-80%, use heat insulation that is 15 mm or thicker and if the expected humidity exceeds 80%, use heat insulation that is 20 mm or thicker.
- If heat insulation is used that is not as thick as specified, condensation may form on the surface of the insulation.
- In addition, use heat insulation with heat conductivity of 0.045 W/(m·K) or less (at 20 °C).

Connect the connection pipes according to "3.5. Pipe installation" in this installation Manual.

2.4. Electrical requirements

WARNING

- Always use a special branch circuit and install a special receptacle to supply power to the air conditioner.
- Use a special branch circuit breaker and receptacle matched to the capacity of the air conditioner. (Install in accordance with standard.)
- Perform wiring work in accordance with standards so that the air conditioner can be operated safely and positively.
- Install a leakage special branch circuit breaker in accordance with the related laws and regulations and electric company standards.

CAUTION

- When the voltage is low and the air conditioner is difficult to start, contact the power company the voltage raised.
- Be sure to install a breaker of the specified capacity.
- Regulation of cables and breaker differs from each locality, refer in accordance with local rules.

Voltage rating	1 Φ 230 V (50 Hz)
Operating range	198 to 264 V

Cable	Cable size (mm ²) ^{*1}	Type	Remarks
Power supply cable	2.5	Type 60245 IEC 57	2 cable + Earth (Ground), 1 \varnothing 230V
Connection cable	1.5	Type 60245 IEC 57	3 cable + Earth (Ground), 1 \varnothing 230V

^{*1} Selected sample: Select the correct cable type and size according to the country or region's regulations.
Max. wire length: Set a length so that the voltage drop is less than 2%. Increase the wire diameter when the wire length is long.

Breaker	Specification ^{*2}	
Circuit breaker (over current)	18 model	Current : 15 (A)
	24 model	Current : 20 (A)
Earth leakage breaker	Leakage current : 30mA 0.1sec or less ^{*3}	

^{*2} Select the appropriate breaker of the described specification according to the national or regional standards.

^{*3} Select the breaker that enough load current can pass through it.

- Before starting work check that power is not being supplied to all poles of the indoor unit and outdoor unit.
- Install all electrical works in accordance to standard.
- Install the disconnect device with a contact gap of at least 3mm in all poles nearby the units. (Both indoor unit and outdoor unit)
- Wiring size must comply with the applicable local and national code.

2.5. Additional charge amount

⚠ CAUTION

- When adding refrigerant, add the refrigerant from the charging port at the completion of work.

Refrigerant suitable for a total piping length of 30 m is charged in the outdoor unit at the factory.

When the piping is longer than 30 m additional charging is necessary. For the additional amount, refer to the following table.

Additional charge amount

Total piping length	30 m	40 m	50 m	Rate
Additional refrigerant	None	200 g	400 g	20 g/m

2.6. General information

- If the unit is operated outside the operating temperature range, various protective circuit mechanisms may be activated and the unit may stop operating. For the operating temperature range, refer to the product FICHE or the specification manual.

3. INSTALLATION WORK

Obtain the approval of the customer when selecting the location of installation and installing the unit.

⚠ WARNING

- Securely install the outdoor unit at a location that can withstand the weight of the unit. Otherwise, the outdoor unit may fall and cause injury.
- Be sure to install the outdoor unit as prescribed, so that it can withstand earthquakes and typhoons or other strong winds. Improper installation can cause the unit to topple or fall, or other accidents.
- To deal with unpredictable weather conditions caused by climate change, fix the outdoor unit(s) to mounting racks or mounting lifters with bolts securely. In addition, consider reinforcing the fixing with strapping down, caging, adding fixtures, etc., so that it can withstand unpredictable high-velocity winds. Failing to follow these requirements can result in system damage, system failure, personal injury, structural damage, or other property damage. We will assume no responsibility in regards to failures, other defects, and damages incurred by improper installation, such as ignorance of regulatory guidelines or other local codes.
- Do not install the outdoor unit near the edge of a balcony. Otherwise, children may climb onto the outdoor unit and fall off of the balcony.

⚠ CAUTION

- Do not install the outdoor unit in the following areas:
 - Area with high salt content, such as at the seaside. It will deteriorate metal parts, causing the parts to fail or the unit to leak water.
 - Area filled with mineral oil or containing a large amount of splashed oil or steam, such as a kitchen. It will deteriorate plastic parts, causing the parts to fail or the unit to leak water.
 - Area that generates substances that adversely affect the equipment, such as sulfuric gas, chlorine gas, acid, or alkali. It will cause the copper pipes and brazed joints to corrode, which can cause refrigerant leakage.
 - Area containing equipment that generates electromagnetic interference. It will cause the control system to malfunction, preventing the unit from operating normally.
 - Area that can cause combustible gas to leak, contains suspended carbon fibers or flammable dust, or volatile inflammables such as paint thinner or gasoline. If gas leaks and settles around the unit, it can cause a fire.
 - Area that has heat sources, vapors, or the risk of the leakage of flammable gas in the vicinity.
 - Area where small animals may live. It may cause failure, smoke or fire if small animals enter and touch internal electrical parts.
 - Area where animals may urinate on the unit or ammonia may be generated.
- Install the outdoor unit without slant.
- Install the outdoor unit in a well-ventilated location away from rain or direct sunlight.
- If the outdoor unit must be installed in an area within easy reach of the general public, install as necessary a protective fence or the like to prevent their access.
- Install the outdoor unit in a location that would not inconvenience your neighbors, as they could be affected by the airflow coming out from the outlet, noise, or vibration. If it must be installed in proximity to your neighbors, be sure to obtain their approval.
- If the outdoor unit is installed in a cold region that is affected by snow accumulation, snow fall, or freezing, take appropriate measures to protect it from those elements. To ensure a stable operation, install inlet and outlet ducts.
- Install the outdoor unit in a location that is away from exhaust or the vent ports that discharge vapor, soot, dust, or debris.
- Install the indoor unit, outdoor unit, power supply cable, connection cable, and remote controller cable at least 1 m away from a television or radio receivers. The purpose of this is to prevent TV reception interference or radio noise. (Even if they are installed more than 1 m apart, you could still receive noise under some signal conditions.)
- If children under 10 years old may approach the unit, take preventive measures so that they cannot reach the unit.
- Keep the length of the piping of the indoor and outdoor units within the allowable range.
- For maintenance purposes, do not bury the piping.

Decide the mounting position with the customer as follows:

- Install the outdoor unit in a location which can withstand the weight of the unit and vibration, and which can install horizontally.
- Provide the indicated space to ensure good airflow.
- If possible, do not install the unit where it will be exposed to direct sunlight. (If necessary, install a blind that does not interfere with the airflow.)
- Do not install the unit near a source of heat, steam, or flammable gas.
- During heating operation, drain water flows from the outdoor unit. Therefore, install the outdoor unit in a place where the drain water flow will not be obstructed.
- Do not install the unit where strong wind blows or where it is very dusty.
- Do not install the unit where people pass.
- Install the outdoor unit in a place where it will be free from being dirty or getting wet by rain as much as possible.
- Install the unit where connection to the indoor unit is easy.

3.1. Installation dimensions

⚠ WARNING

- Do not install where there is the danger of combustible gas leakage.
- Do not install the unit near heat source of heat, steam, or flammable gas.
- If children under 10 years old may approach the unit, take preventive measures so that they cannot reach the unit.

⚠ CAUTION

- Select installation locations that can properly support the weight of the indoor and outdoor units. Install the units securely so that they do not topple or fall.
- Install the unit where it will not be tilted by more than 3°. However, do not install the unit with it tilted towards the side containing the compressor.
- When installing the outdoor unit where it may be exposed to strong wind, fasten it securely.
- Keep the space shown in the installation examples. If the installation is not performed accordingly, it could cause a short circuit and result in a lack of operating performance.

■ Outdoor unit installation

When the upper space is open (Unit : mm)

(1) Obstacles at rear only

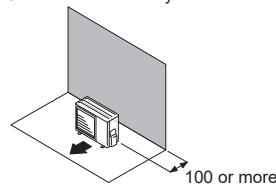

(2) Obstacles at rear and sides

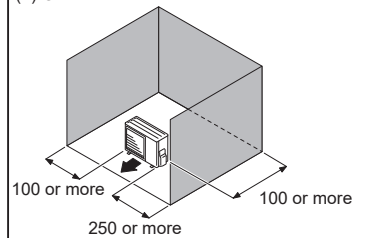

(3) Obstacles at front

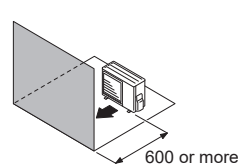

(4) Obstacles at front and rear

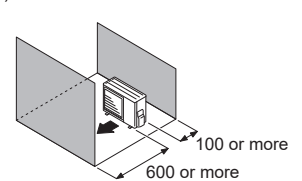

When an obstruction in the upper space (Unit : mm)

(1) Obstacles at rear and above

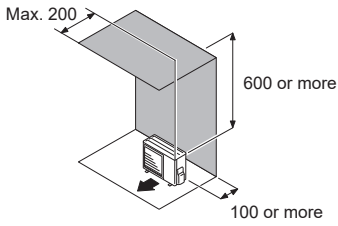

(2) Obstacles at rear, sides, and above

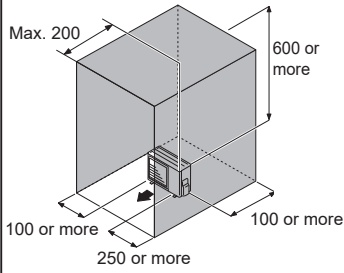

Multiple outdoor unit installation

- Provide at least 250 mm of space between the outdoor units if multiple units are installed.
- When routing the piping from the side of an outdoor unit, provide space for the piping.

When the upper space is open (Unit : mm)

(1) Obstacles at rear only

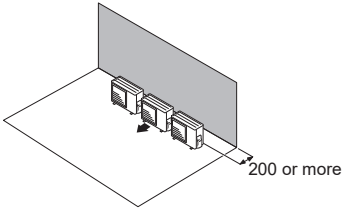

(2) Obstacles at front only

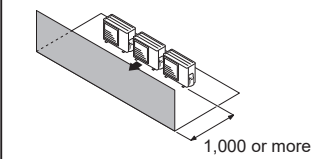

(3) Obstacles at front and rear

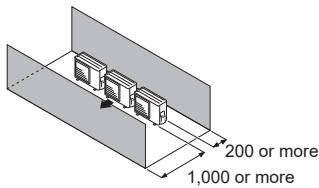

When an obstruction in the upper space (Unit : mm)

(1) Obstacles at rear and above

- Up to 3 units can be installed side by side.
- When 4 units or more are arranged in a line, provide the space as shown below.

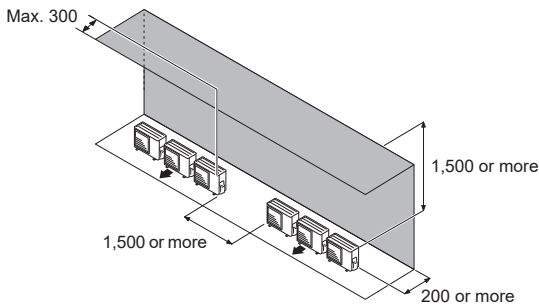

Outdoor units installation multi-row (Unit : mm)

(1) Single parallel unit arrangement

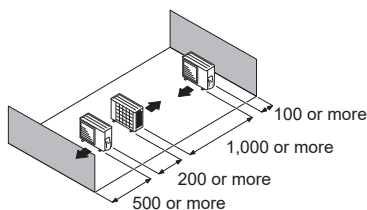

(2) Multiple parallel unit arrangement

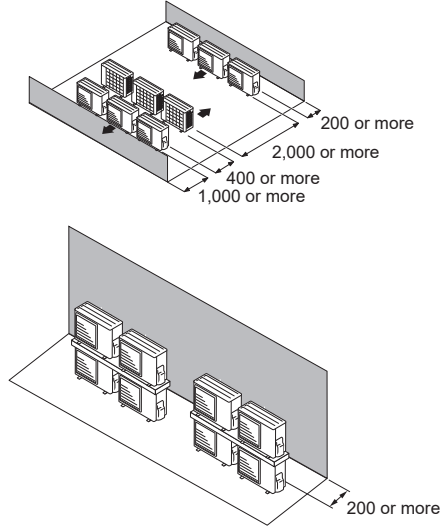

CAUTION

- Do not install the outdoor unit in two stage if the drain water may freeze.
- Otherwise the drainage from the upper unit may form ice and cause a malfunction of the lower unit.

NOTES:

- If the space is larger than stated above, the condition will be the same as when there is no obstacle.
- When installing the outdoor unit, be sure to open the front and left side to obtain better operation efficiency.

3.2. Mounting the unit

- Install 4 anchor bolts at the locations indicated with arrows in the figure.
- To reduce vibration, do not install the unit directly on the ground. Install it on a secure base (such as concrete blocks).
- Depending on the installation conditions, the outdoor unit may spread its vibration during operation, which may cause noise and vibration. Therefore, attach damping materials (such as damping pads) to the outdoor unit during installation.
- Install the foundation, making sure that there is enough space for installing the connection pipes.
- Secure the unit to a solid block using foundation bolts. (Use 4 sets of commercially available M10 bolts, nuts, and washers.)
- The bolts should protrude 20 mm. (Refer to the figure.)
- If overturning prevention is required, purchase the necessary commercially available items.
- The foundation shall support the legs of the unit and have a width of 50 mm or more.

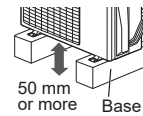

CAUTION

- The drain water is discharged from the bottom of the equipment. Construct a drain ditch around the base and discharge the drain water properly.
- Provide ample space for ice buildup from condensate between the bottom of the unit and the flat surface on which it is mounted. Otherwise, there is risk that the drainage water will freeze between the device and the surface, disabling drainage.
- If the unit is installed in a region that is exposed to high winds, freezing conditions, freezing rain, snow fall or heavy snow accumulation, take appropriate measures to protect it from those elements. To ensure stable operation, the outdoor unit must be installed on a raised stand or rack, at or above the anticipated snow depth for the region. The installation of snow hoods and drift prevention fencing is recommended when blowing and drifting snow is common to the region.

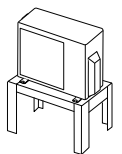

(Unit : mm)

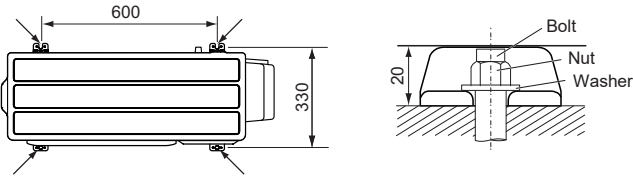

3.3. Removing and replacing part

■ The switch cover and the terminal cover removal

- (1) Remove the tapping screws.
- (2) Slide the switch cover downwards to release.

■ Installing the switch cover

- (1) After inserting the hooks (2 places) on the switch cover into the hole on the outdoor unit, slide the switch cover upwards.
- (2) Replace the tapping screws.

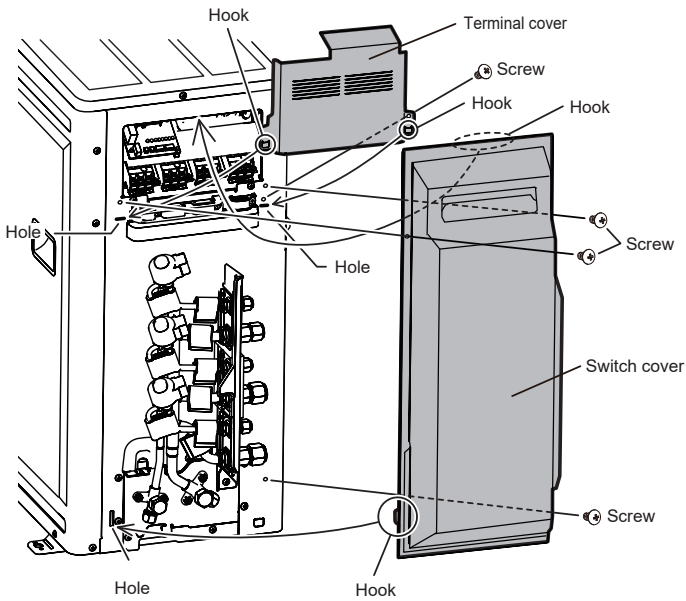

3.4. Drain installation

⚠ CAUTION

- Perform drain work in accordance with this Manual, and ensure that the drain water is properly drained. If the drain work is not carried out correctly, water may drip down from the unit, wetting the furniture.
- When the outdoor temperature is 0 °C or less, do not use the accessory drain pipe and drain cap. If the drain pipe and drain cap are used, the drain water in the pipe may freeze in extremely cold weather. (Reverse cycle model only)
- Outdoor unit to be fasten with bolts at the four places indicated by the arrows without fail.

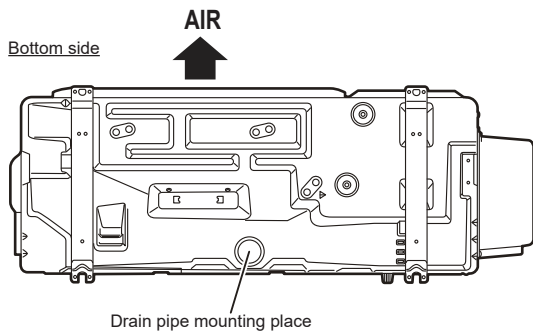

Since the drain water flows out of the outdoor unit during heating operation, install the drain pipe and connect it to a commercial 16 mm hose. (Reverse cycle model only)
When installing the drain pipe, plug all the holes other than the drain pipe mounting hole in the bottom of the outdoor unit with putty so there is no water leakage. (Reverse cycle model only)

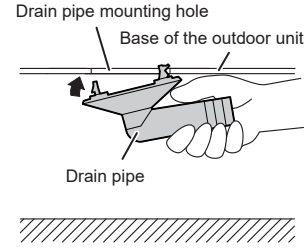

3.5. Pipe installation

⚠ CAUTION

- Do not use mineral oil on a flared part. Prevent mineral oil from getting into the system as this would reduce the lifetime of the units.
- While welding the pipes, be sure to blow dry nitrogen gas through them.

■ Flaring

- (1) Cut the connection pipe to the necessary length with a pipe cutter.
- (2) Hold the pipe downward so that cuttings will not enter the pipe and remove the burrs.
- (3) Insert the flare nut onto the pipe and flare the pipe with a flaring tool.
Insert the flare nut (always use the flare nut attached to the indoor and outdoor units respectively) onto the pipe and perform the flare processing with a flare tool. Use the special R32(R410A) flare tool, or the conventional (for R22) flare tool. When using the conventional flare tool, always use an allowance adjustment gauge and secure the A dimension shown in the following table.

Check if [L] is flared uniformly and is not cracked or scratched.

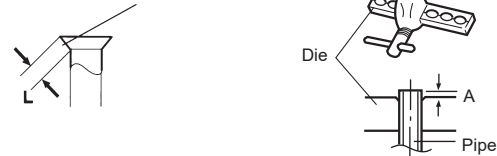

Pipe outside diameter	A (mm)		
	Flaring tool for R32 or R410A, clutch type	Conventional (R22) Flaring tool	
		Clutch type	Wing nut type
ø 6.35 mm (1/4")	0 to 0.5	1.0 to 1.5	1.5 to 2.0
ø 9.52 mm (3/8")			
ø 12.70 mm (1/2")			
ø 15.88 mm (5/8")			
ø 19.05 mm (3/4")			

■ Bending pipes

⚠ CAUTION

- To prevent breaking of the pipe, avoid sharp bends. Bend the pipe with a radius of curvature of 100mm or more.
- If the pipe is bent repeatedly at the same place, it will break.
- If pipes are shaped by hand, be careful not to collapse them.
- Do not bend the pipes at an angle of more than 90°.
- When pipes are repeatedly bent or stretched, the material will harden, making it difficult to bend or stretch them any more.
- Do not bend or stretch the pipes more than 3 times.

■ Flare connection

⚠ CAUTION

- Be sure to install the pipe against the port on the indoor unit and the outdoor unit correctly. If the centering is improper, the flare nut cannot be tightened smoothly. If the flare nut is forced to turn, the threads will be damaged.
- Do not remove the flare nut from the outdoor unit pipe until immediately before connecting the connection pipe.
- After installing the piping, make sure that the connection pipes do not touch the compressor or outer panel. If the pipes touch the compressor or outer panel, they will vibrate and produce noise.
- If there are a large number of flare connections due to the number of indoor units connected, please confirm that the valves that are not connected are closed. Not doing so may cause a refrigerant leak.
- When connecting the indoor unit, it should be connected in the order of port A, B, C, and so on. Please be sure to close remaining unconnected ports so that they do not leak refrigerant.

- (1) Detach the caps and plugs from the pipes.
- (2) Center the pipe against the port on the outdoor unit, and then turn the flare nut by hand.

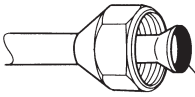

To prevent gas leakage, coat the flare surface with alkylbenzene oil (HAB). Do not use mineral oil.

- (3) Attach the connection pipe.

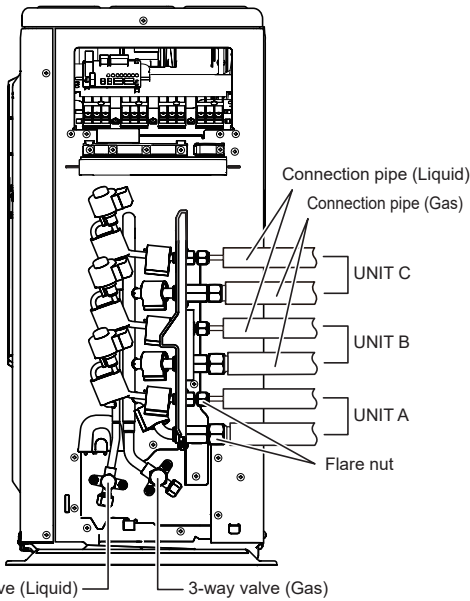

- (4) When the flare nut is tightened properly by your hand, use a torque wrench to finally tighten it.

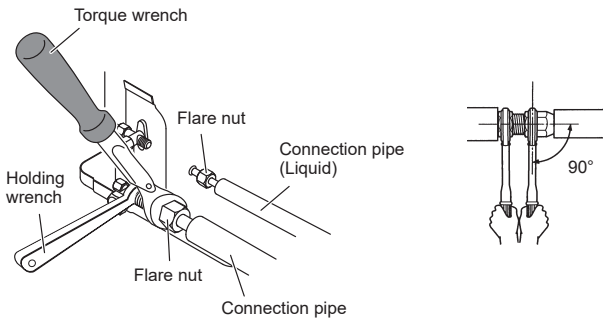

CAUTION

- Hold the torque wrench at its grip, keeping it in a right angle with the pipe, in order to tighten the flare nut correctly.

Outer panel may be distorted if fastened only with a wrench. Be sure to fix the elementary part with a holding wrench (spanner) and fasten with a torque wrench (refer to below diagram). Do not apply force to the blank cap of the valve or hang a wrench, etc., on the cap. If blank cap is broken, it may cause leakage of refrigerant.

Flare nut [mm (in.)]	Tightening torque [N·m (kgf·cm)]
6.35 (1/4) dia.	16 to 18 (160 to 180)
9.52 (3/8) dia.	32 to 42 (320 to 420)
12.70 (1/2) dia.	49 to 61 (490 to 610)
15.88 (5/8) dia.	63 to 75 (630 to 750)
19.05 (3/4) dia.	90 to 110 (900 to 1100)

CAUTION

- Fasten a flare nut with a torque wrench as instructed in this manual. If fastened too tight, the flare nut may be broken after a long period of time and cause a leakage of refrigerant.
- During installation, make sure that the refrigerant pipe is attached firmly before you run the compressor. Do not operate the compressor under the condition of refrigerant piping not attached properly with 3-way valves open. This may cause abnormal pressure in the refrigeration cycle that leads to breakage and even injury.

3.6. Sealing test

WARNING

- Before operating the compressor, install the pipes and securely connect them. Otherwise, if the pipes are not installed and if the valves are open when the compressor operates, air could enter the refrigeration cycle. If this happens, the pressure in the refrigeration cycle will become abnormally high and cause damage or injury.
- After the installation, make sure there is no refrigerant leakage. If the refrigerant leaks into the room and becomes exposed to a source of fire such as a fan heater, stove, or burner, it produces a toxic gas.
- Do not subject the pipes to strong shocks during the sealing test. It can rupture the pipes and cause serious injury.

CAUTION

- Do not block the walls and the ceiling until the sealing test and the charging of the refrigerant gas have been completed.
- For maintenance purposes, do not bury the piping of the outdoor unit.
- After connecting the pipes, perform a sealing test.
- Make sure that the 3-way valves are closed before performing a sealing test.
- Pressurize nitrogen gas to 4.15 MPa to perform the sealing test.
- Add nitrogen gas to both the liquid pipes and the gas pipes.
- Check all flare connections and welds. Then, check that the pressure has not decreased.
- Compare the pressures after pressurizing and letting it stand for 24 hours, and check that the pressure has not decreased.
 - * When the outdoor air temperature changes 5 °C, the test pressure changes 0.05 MPa. If the pressure has dropped, the pipe joints may be leaking.
- If a leak is found, immediately repair it and perform the sealing test again.
- After completing the sealing test, release the nitrogen gas from both valves.
- Release the nitrogen gas slowly.

3.7. Vacuum process

CAUTION

- Do not turn on the power unless all operations are complete.
- If the system is not evacuated sufficiently, its performance will drop.
- Be sure to evacuate the refrigerant system using a vacuum pump.
- The refrigerant pressure may sometimes not rise when a closed valve is opened after the system is evacuated using a vacuum pump. This is caused by the closure of the refrigerant system of the outdoor unit by the electronic expansion valve. This will not affect the operation of the unit.
- Use a clean gauge manifold and charging hose that were designed specifically for use with R410A. Using the same vacuum equipment for different refrigerants may damage the vacuum pump or the unit.
- Do not purge the air with refrigerants, but use a vacuum pump to evacuate the system.
 - If moisture might enter the piping, follow below. (i.e., if doing work during the rainy season, if the actual work takes long enough that condensation may form on the inside of the pipes, if rain might enter the pipes during work, etc.)
- After operating the vacuum pump for 2 hours, pressurize to 0.05 MPa (i.e., vacuum breakdown) with nitrogen gas, then depressurize down to -100.7kPa (-755mmHg) for an hour using the vacuum pump (vacuum process).
- If the pressure does not reach -100.7kPa (-755mmHg) even after depressurizing for at least 2 hours, repeat the vacuum breakdown - vacuum process.
- After vacuum process, maintain the vacuum for an hour and make sure the pressure does not rise by monitoring with a vacuum gauge.

Evacuation procedure

- (1) Remove the blank caps of the gas pipe and liquid pipe and check that the valves are closed.
- (2) Remove the charging port cap.
- (3) Connect a vacuum pump and a pressure gauge to a charging hose and connect it to the charging port.
- (4) Activate the vacuum pump and vacuum the indoor unit and connection piping until the pressure gauge becomes -100.7kPa (-755mmHg). Evacuate from both the gas pipe and the liquid pipe.
- (5) Continue evacuating the system for 1 hour after the pressure gauge reads -100.7kPa (-755mmHg).
- (6) Remove the charging hose and reinstall the charging port cap.

Table.A

Pipe	3-way valve	Blank cap	Charging port cap
Liquid valve	7.0 to 9.0 N·m (70 to 90 kgf·cm)	20.0 to 25.0 N·m (200 to 250 kgf·cm)	12.5 to 16.0 N·m (125 to 160 kgf·cm)
Gas valve	11.0 to 13.0 N·m (110 to 130 kgf·cm)	30.0 to 35.0 N·m (300 to 350 kgf·cm)	12.5 to 16.0 N·m (125 to 160 kgf·cm)

Fig.A Connection system

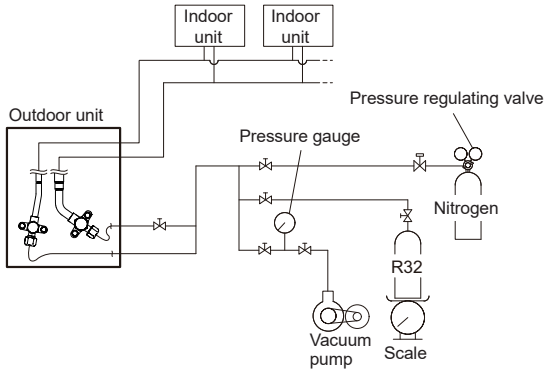
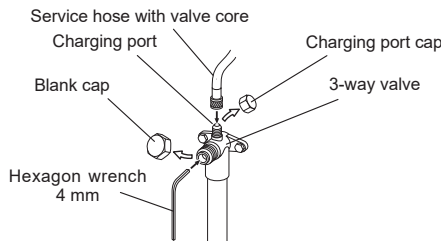

Fig.B



3.8. Additional charging

⚠ WARNING

- When moving and installing the air conditioner, do not mix gas other than the specified refrigerant R32 inside the refrigerant cycle. If air or other gas enters the refrigerant cycle, the pressure inside the cycle will rise to an abnormally high value and cause breakage, injury, etc.

Charge the refrigerant following the instruction in "2.5. Additional charge amount".

⚠ CAUTION

- After vacuuming the system, add refrigerant.
- Do not reuse recovered refrigerant.
- When charging the refrigerant R32, always use an electronic scales for refrigerant charging (to measure the refrigerant by weight). Adding more refrigerant than the specified amount will cause a malfunction.
- When charging the refrigerant, take into account the slight change in the composition of the gas and liquid phases, and always charge from the liquid phase side whose composition is stable.
- Check if the steel cylinder has a siphon installed or not before filling. (There is an indication "with siphon for filling liquid" on the steel cylinder.)

Filling method for cylinder with siphon

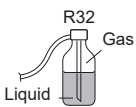

Set the cylinder vertical and fill with the liquid.
(Liquid can be filled without turning bottom up with the siphon inside.)

Filling method for other cylinders

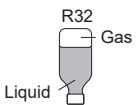

Turn bottom up and fill with liquid.
(Be careful to avoid turning over the cylinder.)

- Be sure to use the special tools for R32(R410A) for pressure resistance and to avoid mixing of impure substances.
- If the units are further apart than the maximum pipe length, correct operation can not be guaranteed.
- Make sure to back closing valve after refrigerant charging. Otherwise, the compressor may fail.
- Minimize refrigerant release to the air. Excessive release is prohibited under the Freon Collection and Destruction Law.

3.9. Electrical wiring

⚠ WARNING

- Wiring connections must be performed by a qualified person in accordance with the specifications. The voltage rating for this product is 230 V at 50 Hz. It should be operated within the range of 198 to 264 V.
- Before connecting the wires, make sure the power supply is off.
- Never touch electrical components immediately after the power supply has been turned off. Electrical shock may occur. After turning off the power, always wait 10 minutes or more before touching electrical components.
- Use a dedicated power supply circuit. Insufficient power capacity in the electrical circuit or improper wiring may cause electric shock or fire.
- Be sure to install an earth leakage breaker. Otherwise, it will cause electric shock or fire.
- A circuit breaker is installed in the permanent wiring. Always use a circuit that can trip all the poles of the wiring and has an isolation distance of at least 3 mm between the contacts of each pole.
- Use designated cables and power cables. Improper use may cause electric shock or fire by poor connection, insufficient insulation, or over current.
- Do not modify power cable, use extension cable or branch wiring. Improper use may cause electric shock or fire by poor connection, insufficient insulation or over current.
- Connect the connector cable securely to the terminal. Check no mechanical force bears on the cables connected to the terminals. Faulty installation can cause a fire.
- Use ring terminals and tighten the terminal screws to the specified torques, otherwise, abnormal overheating may be produced and possibly cause serious damage inside the unit.
- Make sure to secure the insulation portion of the connector cable with the cable clamp. Damaged insulation can cause a short circuit.
- Fix cables so that cables do not make contact with the pipes (especially on high pressure side). Do not make power supply cable and transmission cable come in contact with valves (Gas).
- Never install a power factor improvement condenser. Instead of improving the power factor, the condenser may overheat.
- Be sure to perform the grounding work. Do not connect grounding wires to a gas pipe, water pipe, lightning rod or grounding wire for a telephone.
 - Connection to a gas pipe may cause a fire or explosion if gas leaks.
 - Connection to a water pipe is not an effective grounding method if PVC pipe is used.
 - Connection to the grounding wire of a telephone or to a lightning rod may cause a dangerously abnormal rise in the electrical potential if lightning strikes.
 - Improper grounding work can cause electric shocks.
- Securely install the electrical box cover on the unit. An improperly installed service panel can cause serious accidents such as electric shock or fire through exposure to dust or water.
- Do not connect the AC power supply to the transmission line terminal board. Improper wiring can damage the entire system.
- Before servicing the unit, turn the power supply switch OFF. Then, do not touch electric parts for 5 minutes due to the risk of electric shock.
- Make sure to perform grounding work. Improper grounding work can cause electric shocks.

⚠ CAUTION

- The primary power supply capacity is for the air conditioner itself, and does not include the concurrent use of other devices.
- If the electrical power is inadequate, contact your electric power company.
- Install a breaker in a location that is not exposed to high temperatures. If the temperature surrounding the breaker is too high, the amperage at which the breaker cuts out may decrease.
- When using an earth leakage breaker that has been designed solely for ground fault protection, be sure to install a fuse-equipped switch or circuit breaker.
- This system uses an inverter, which means that it must be used an earth leakage breaker that can handle harmonics in order to prevent malfunctioning of the earth leakage breaker itself.
- Do not use crossover power supply wiring for the outdoor unit.
- If the temperature surrounding the breaker is too high, the amperage at which the breaker cuts out may decrease.
- When the electrical switchboard is installed outdoors, place it under lock and key so that it is not easily accessible.
- Start wiring work after closing branch switch and over current breaker.
- Transmission cable between indoor unit and outdoor unit is 230 V.
- Be sure not to remove thermistor sensor etc. from power wiring and connection wiring. Compressor may fail if operated while removed.
- Always keep to the maximum length of the connection cable. Exceeding the maximum length may lead to erroneous operation.
- Do not start operation until the refrigerant is charged completely. The compressor will fail if it is operated before the refrigerant piping charging is complete.
- The static electricity that is charged to the human body can damage the control PC Board when handling the control PC Board for address setting, etc. Keep caution to the following points. Provide the grounding of Indoor unit, Outdoor unit and Option equipment. Cut off the power supply (breaker). Touch the metal section (such as the unpainted control box section) of the indoor or outdoor unit for more than 10 seconds. Discharge the static electricity in your body. Never touch the component terminal or pattern on the PC Board.
- Be careful not to generate a spark as follows for using a flammable refrigerant.
 - Do not remove the fuse while power is on.
 - Do not disconnect plug from the wall outlet and the wiring while the power is on.
 - It is recommended to position the outlet connection in a high position. Place the cords so that they do not get tangled.

CAUTION

- Confirm the indoor unit model name before connecting. If the indoor unit is not R32 compatible, error signal will be displayed, and the unit will be inoperable.
- Do not fasten the power supply cable and connection cable together.

How to connect wiring to the terminal

- When stripping off the coating of a lead wire, always use a special tool such as a wire stripper. If there is no special tool available, carefully strip the coating with a knife etc.

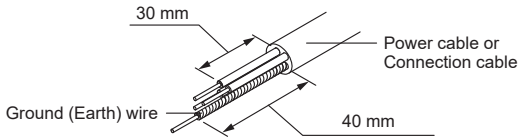

Caution when wiring cable

- (1) Use ring terminals with insulating sleeves as shown in the figure to connect to the terminal block.
- (2) Securely clamp the ring terminals to the wires using an appropriate tool so that the wires do not come loose.
- (3) Use the specified wires, connect them securely, and fasten them so that there is no stress placed on the terminals.
- (4) Use an appropriate screwdriver to tighten the terminal screws. Do not use a screwdriver that is too small, otherwise, the screw heads may be damaged and prevent the screws from being properly tightened.
- (5) Do not tighten the terminal screws too much, otherwise, the screws may break.
- (6) Refer to the following table for the terminal screw tightening torques.

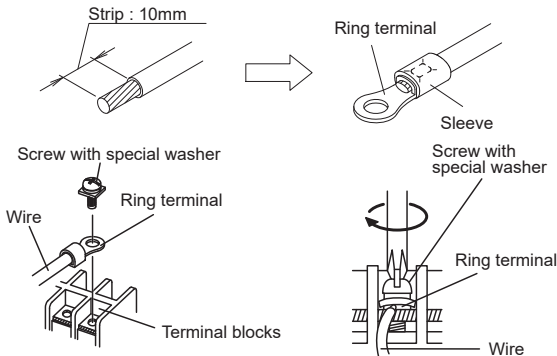

Tightening torque [N·m (kgf·cm)]

M4 screw	1.2 to 1.8 (12 to 18)
----------	-----------------------

Connection diagrams

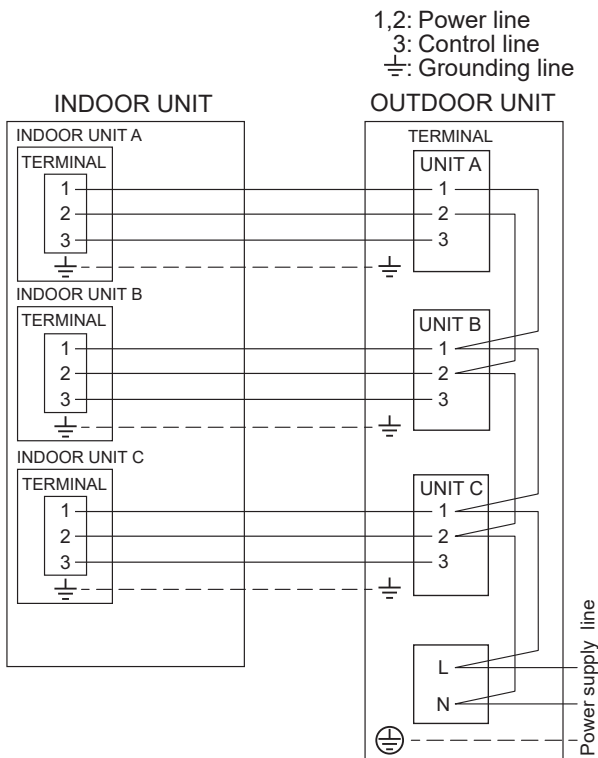

Outdoor unit

- (1) The switch cover and the terminal cover removal
 - Remove the fixing screws.
 - Lift the switch cover upward, and then pull it outward to remove it.

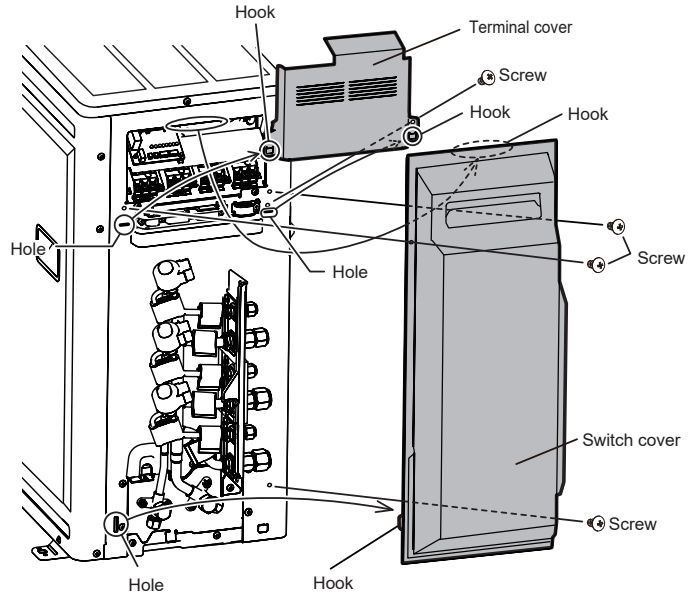

- (2) Connect the power supply cable and the connection cable to terminal. Fasten the power supply cable and connection cable with cable clamp.

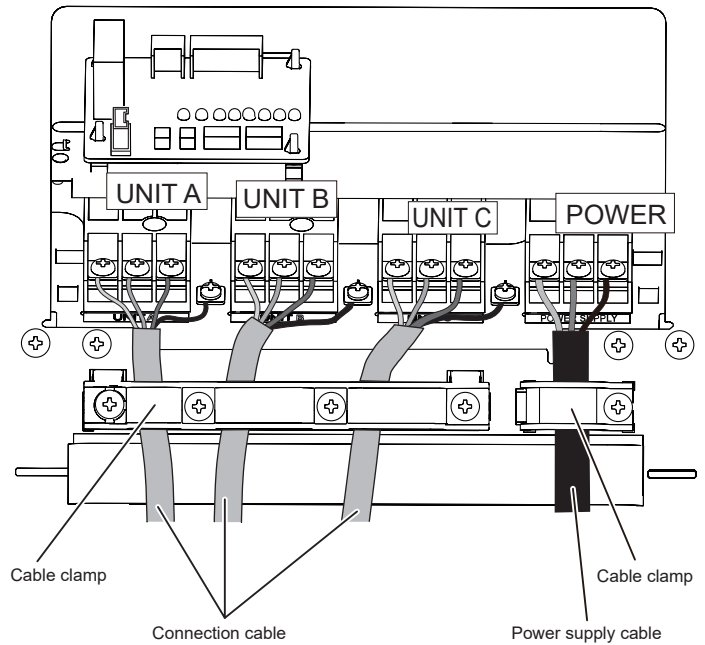

NOTE: Connect the cable to the UNIT terminal according to the number of indoor units.

(3) As illustrated, draw out the power cable and the connection cable.

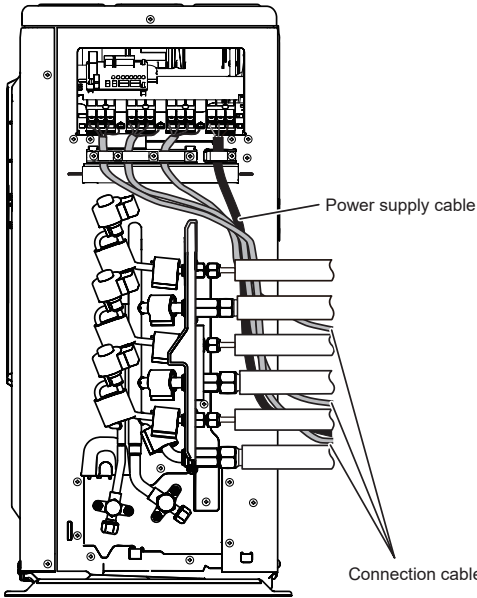

(4) Install the terminal cover.

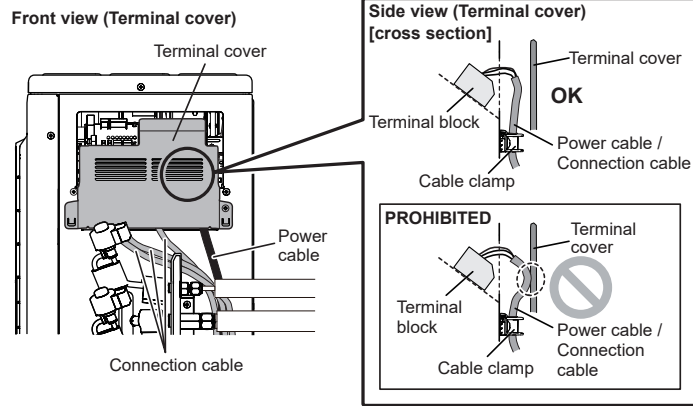

NOTE: Pay attention not to get the cable caught when attaching the terminal cover.

(5) Install the switch cover.

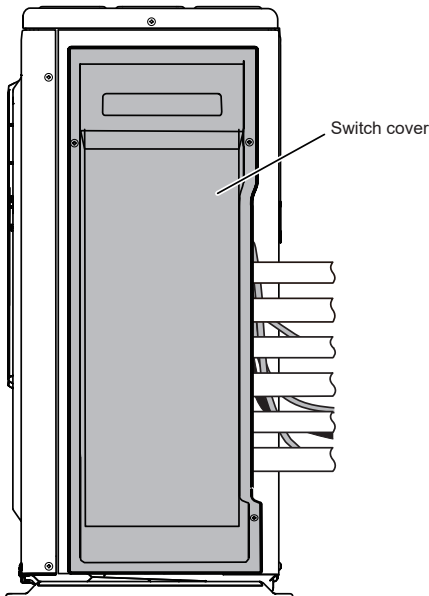

4. HOW TO OPERATE DISPLAY UNIT

4.1. Various setting methods

⚠ WARNING

- Never touch electrical components such as the terminal blocks or reactor except the switch on the display board. It may cause a serious accident such as electric shock.

⚠ CAUTION

- Once refrigerant charging is completed, be sure to open the valve prior to performing the local settings. Otherwise, the compressor may fail.
- Discharge any static electricity from your body before touching the push switches. Never touch any terminal or pattern of any parts on the control board.

- The positions of the switches on the outdoor unit control board are shown in the figure below.

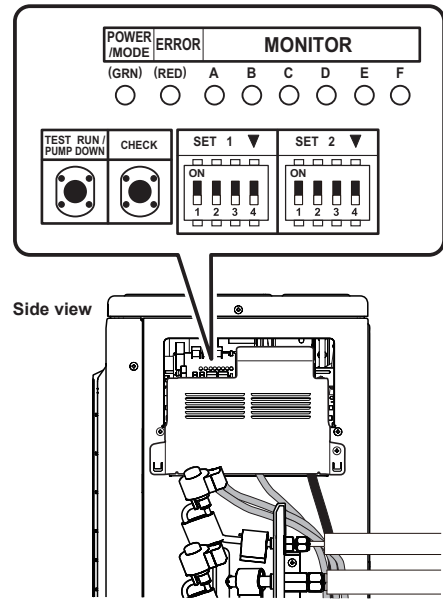

■ Setting method

- (1) Be sure to disconnect the power source or turn off the breaker.
- (2) Change the DIP switch setting according to the required setting.
 - Various settings can be adjusted by changing DIP switches and push switches on the board of the outdoor unit.
 - The printed characters for the LED display are shown below.

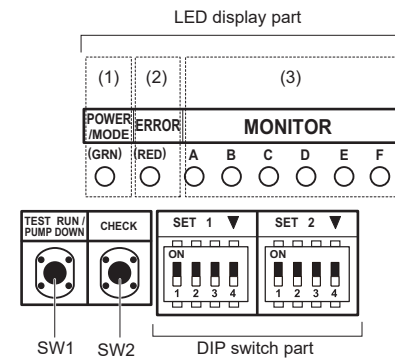

■ Description of display

LED display lamp		Function or operation method	
(1)	POWER/MODE	Green	<ul style="list-style-type: none"> • Turns on when the power supply is ON (Including when error occurs). • Indicate the MODE by the number of flashes when the installation function is active.
(2)	ERROR	Red	<ul style="list-style-type: none"> • Flashes at high-speed when there is an error.
(3)	MONITOR	A	Red
		B	Red
		C	Red
		D	Red
		E	Red
		F	Red
			<ul style="list-style-type: none"> • Displays the location and contents of errors when there is an error. (Refer to 7. ERROR CODE for details.) • Displays when check run is activated. (Refer to 5. CHECK RUN for details.)

Switch		Function or operation method	Factory setting
SW1	Push	<ul style="list-style-type: none"> For the test run start and stop. For the pump down start and stop. 	—
SW2	Push	<ul style="list-style-type: none"> For when check run function is activated. For displaying the check run. For resetting the Automatic wiring correction memory. 	—
SET1-1	DIP	<ul style="list-style-type: none"> For selecting cooling or heating during test operation. 	OFF
SET1-2	DIP	<ul style="list-style-type: none"> For switching SW1 operation. 	OFF
SET1-3	DIP	(Setting prohibited)	OFF (Do not change)
SET1-4	DIP	<ul style="list-style-type: none"> Outdoor unit low noise operation function 	OFF
SET2-1	DIP	<ul style="list-style-type: none"> For selecting outdoor unit low noise operation function. 	OFF
SET2-2	DIP	(Setting prohibited)	OFF (Do not change)
SET2-3	DIP	<ul style="list-style-type: none"> Changing the current limit 	OFF
SET2-4	DIP		

Be sure to disconnect the power source or turn off the breaker when changing the DIP switch.

4.2. Outdoor unit low noise operation function (option)

⚠ CAUTION

- When the low noise operation function is working, cooling and heating capacity will decrease.
- When changing the settings, explain to the customer beforehand that the capacity decreases.

- Change the Outdoor unit low noise operation by using this setting.
- When SET1-4 is OFF, the Central remote controller (optional parts) is required to use this function.
- When SET1-4 is ON, "Operation" and "Non-operation" mode of this function cannot be switched from the Central remote controller.

SET1-4	Setting	SET2-1	Setting
ON	Continuous operation	ON	Lower
OFF	Follow the Central remote controller settings	OFF	Low

4.3. Changing the current limit function

⚠ CAUTION

- When the current limit function is working, cooling and heating capacity will decrease.
- When changing the settings, explain to the customer beforehand that the capacity decreases.

Change the Outdoor unit current limit function by using this setting.

SET2-3	SET2-4	18 model	24 model
OFF	OFF	Full	
ON	OFF	10.0 A	12.0 A
OFF	ON	8.0 A	10.5 A

5. CHECK RUN

- The check run is a function to screen and detect any wiring errors.
- After carrying out the check run, you can use the Automatic wiring correction function to correct the wiring.
- * Normal operation is possible without using the check run. In this case, use the test run or forced cooling function of the indoor unit to confirm any wiring errors.

5.1. Things to confirm before starting the check run

To ensure safety, check that the following work, inspections and operations have been completed.

Check Item	Check Column
① Check that all work on the piping connecting the outdoor unit, indoor units has been completed	
② Check that all work on the wiring connecting the outdoor unit, indoor units has been completed	
③ Is there a gas leakage? [At pipe connections (flange connections and brazed areas)]	
④ Is the system charged with the specified volume of refrigerant?	
⑤ Is a breaker installed at the power supply cable of outdoor unit?	
⑥ Are the wires connected to the terminals without looseness, and in accordance with the specifications?	
⑦ Is the 3-way valve of the outdoor unit open? (Gas pipe and liquid pipe)	
⑧ Is the power supply connected for more than 12 hours?	

5.2. Restrictions applicable when performing the check run

- When the check run starts, all indoor units connected to the outdoor unit will start to run automatically. During the check run, you cannot check the operation of the indoor units separately. After the check run, check the operation of the indoor units separately in normal operation.
- The check run can be used when the temperature is within the operable temperature of the air conditioner.
- In the check run, the air conditioner will automatically switch between cooling and heating depending on the external temperature and internal temperature.
- The check run can be completed in about 30 minutes (cooling) or about 1 hour (heating), but may take more depending on the external and internal temperature conditions etc.
- Do not conduct the check run with all the windows in the room closed. Otherwise the room temperature could get too low or too high.
- Depending on the difference of the room temperature of each room, a judgment may be impossible.
- Check run is a special operation so there may be a noise louder than the normal refrigerant noise or a creaking noise.

5.3. Operating procedure for check run

⚠ CAUTION

- Initiate check run after more than 12 hours after the power source is connected.

NOTE:

Be sure that the indoor unit and outdoor unit are not operating before starting the check run.

- Press the "CHECK" switch for 3 seconds or more.



- The number of indoor units (and the places) connected through the communication lines is displayed.
 - If the displayed number of units (places) and the installed number of units (places) is the same, proceed to step (3).
 - If the displayed number of units (places) and the installed number of units (places) is not the same, shut off the power and check whether the indoor and outdoor communication lines are properly connected.
 - If there is no operation for 1 minute, the LED will return to the original display. (POWER/MODE LED: ON)
- Press the "CHECK" switch for 3 seconds or more again. Check run is initiated.
 - When check run is initiated, all LEDs from A to F will flash. (Preliminary operation)
 - The LED for each indoor unit will switch off in order as check for each unit is completed.

NOTE:

To interrupt the check run, press the "CHECK" switch.

Example) When 4 indoor units (A to D) are connected

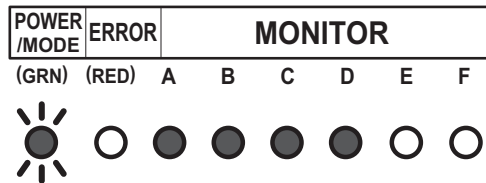

(2-blink)

Example) When 4 indoor units (A to D) are connected

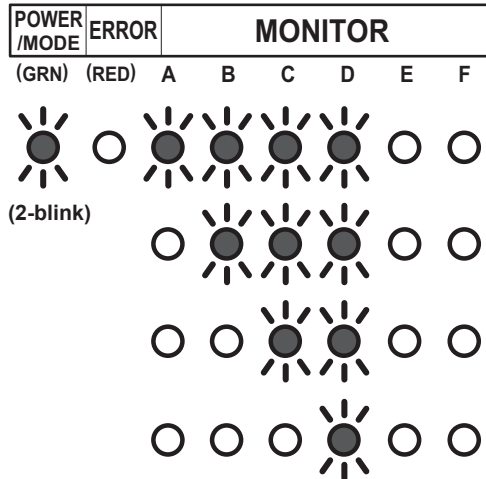

(2-blink)

- After the check run is complete, results will be displayed. Fill the displayed results in the result table accordingly.

NOTES:

- Automatic wiring correction will not be completed if the power is turned off while displaying the results. To confirm the automatic wiring correction, be sure to carry out step (5).
- If frost is formed on the outdoor unit while displaying the results, Automatic defrost function will operate. Proceed to step (5) after the defrost function is finished.

If the connection is correct [(Example) When 4 indoor units are connected]

- After the number of connected units are displayed, the LED for each unit will light up in order from A to D.

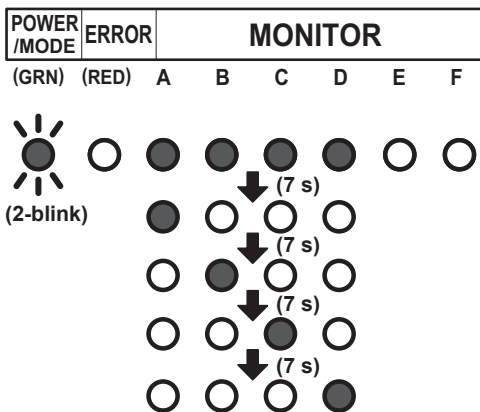

If the connection is incorrect [(Example) When connection of B and C of the 4 units are reversed]

- After the number of connected units are displayed, B and C will light up in reverse.

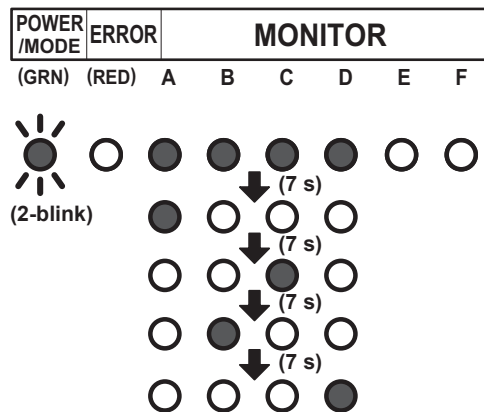

[How to record the contents]

- Fill the displayed results according to the following example.
- Example 1) When piping A to D is connected but the wires for B and C are connected in reverse.
- <Displayed results>
- The LEDs will light up in 7 second intervals in the following order.

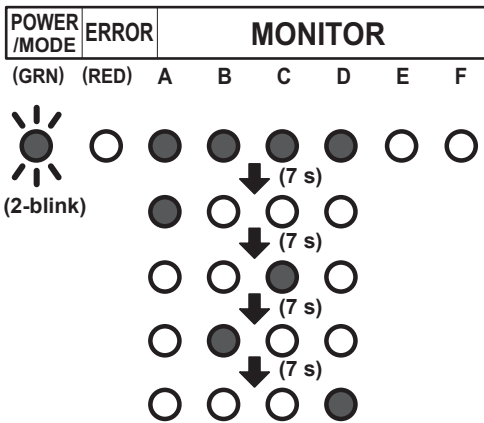

<Example of result table>

(a) Write a ● where the LEDs light up in the order that they light up.

	A	B	C	D	E	F
1	●	●	●	●	○	○
2	●	○	○	○	○	○
3	○	○	●	○	○	○
4	○	●	○	○	○	○
5	○	○	○	●	○	○
6	○	○	○	○	○	○
7	○	○	○	○	○	○

(b) Based on the results of step (a), record as follows.

- Trace the dotted circle with a pen if multiple places light up.

A	B	C	D	E	F
○	○	○	○	⊖	⊖

- Write the order from A to D in which the LEDs lit up inside the circle.

A	B	C	D	E	F
Ⓐ	Ⓒ	Ⓑ	Ⓓ	⊖	⊖

(c) Select the correction method.

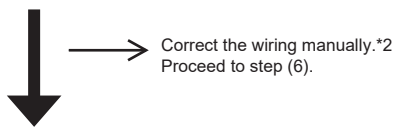

Use the Automatic wiring correction function.*1
Proceed to step (5).

Write down the same results in the label.

The results recorded are needed at the time of servicing.

- (5) During results display, press the "CHECK" switch for 3 seconds or more.
- After LEDs A to F have lit in turn, all LEDs will light up indicating that the automatic wiring correction is completed.

(6) Disconnect the power supply or turn off the breaker and wait 10 minutes then turn the power back on and perform test run.

NOTE:

- If you do not disconnect the power supply or turn off the breaker, normal operation is not possible.

Others

- If an error occurs during check run it will be suspended. Correct the error and start check run again.
- After the check run, if automatic wiring correction is carried out, the indoor unit's position will be modified to match the piping. (Note that the display of the optional remote controller changes.)
- If you start check run again after the automatic wiring correction is finished, the modification will be reset.

<Result Table>

	A	B	C	D	E	F
1	○	○	○	○	○	○
2	○	○	○	○	○	○
3	○	○	○	○	○	○
4	○	○	○	○	○	○
5	○	○	○	○	○	○
6	○	○	○	○	○	○
7	○	○	○	○	○	○

A	B	C	D	E	F
⊖	⊖	⊖	⊖	⊖	⊖

NOTES:

- *1: By using this function, the wiring is automatically corrected according to the piping.
- *2: When correcting the wiring manually, disconnect the power supply or turn off the breaker during results display, and then change the wiring manually according to the obtained test results.
For example, in Example 1, the wirings connected to the terminals B and C is to be exchanged manually.

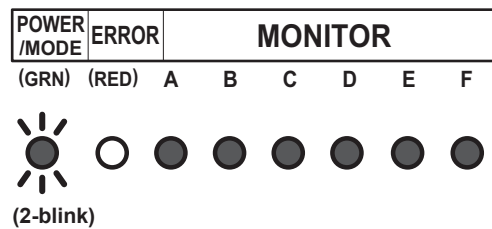

5.4. Check run judgment failure display

- If check run cannot be performed, the following is displayed. In this case, the check run will stop. Check by using the cooling test run of the indoor unit.

Temperature out of range judgment

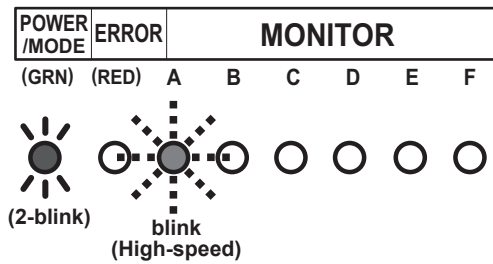

Wiring / piping number difference

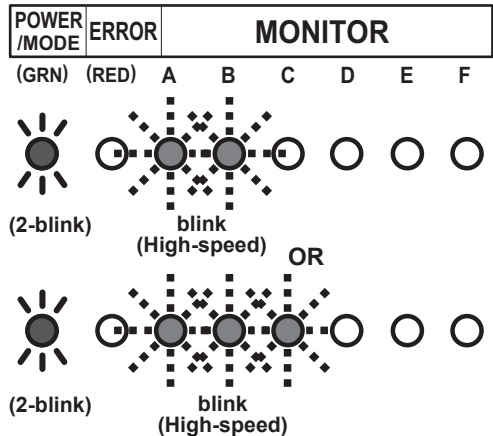

5.5. Re-display check run results

- If you wish to check the automatic wiring correction contents, by briefly pressing the "CHECK" switch, the check run results is displayed. Check the check run results by referring to the result table in step (4) of "5.3. Operating procedure for check run".
- If the automatic wiring correction contents has not been done, the POWER/MODE LED will blink twice and the MONITOR LED will turn off.

5.6. Automatic wiring correction memory reset

⚠ CAUTION

- When relocating the unit, reset the memory beforehand, or the unit may not function normally.

- Press the "CHECK" switch.
The LED will light as shown in "5.5. Re-display check run results".
- Press the "CHECK" switch for more than 3 seconds when the LED is on.
- The LEDs from A to F will light in sequence, and then all LEDs will light to indicate the completion of the Automatic wiring correction memory reset.
- Disconnect the power supply or turn off the breaker.

6. TEST RUN

⚠ CAUTION

- Always connect the power supply 12 hours prior to the start of the operation in order to protect the compressor.

(1) Indoor unit

- Is the drain normal?
- Is there any abnormal noise and vibration during operation?

(2) Outdoor unit

- Is there any abnormal noise and vibration during operation?
- Will noise, wind, or drain water from the unit disturb the neighbors?
- Is there any gas leakage?

- Do not operate the air conditioner in the test running state for a long time.

- For the operation method of the test run for indoor unit and central remote controller, refer to the operation manual and perform operation check.

6.1. TEST RUN method

Be sure to temporarily disconnect the power supply or turn off the breaker before changing the DIP switch settings.

- Check the 3-way valves (both at the liquid side and gas side) are opened. Confirm that the DIP switch SET1-2 is switched OFF.
- Set the operation mode to "COOL" or "HEAT". If you wish to change the DIP switch SET1-1 to "HEAT", switch it after temporarily disconnecting the power supply or turning off the breaker switching the power off.

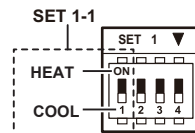

- In the first test run, be sure to set the operation mode to "COOL".
- The operation mode cannot be switched between "COOL" and "HEAT" during the test run. To switch the operation mode between "COOL" and "HEAT", stop the test run, switch the operation mode, and then start the test run again.

- Press "TEST RUN" switch for more than 3 seconds.
The POWER / MODE LED flashes once.



SW1

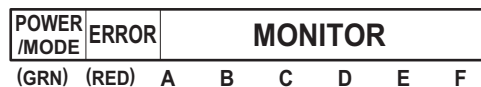

- Confirm operating status.
- Press "TEST RUN" switch for more than 3 seconds.

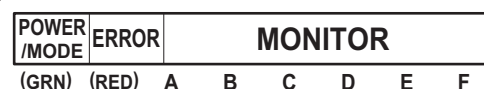

POWER/MODE LED will turn on, and test run stops.

7. ERROR CODE

- If an error occurs, the LED will light up to display the error location and the error code.

7.1. In the event of an error

- The error LED flashes quickly.

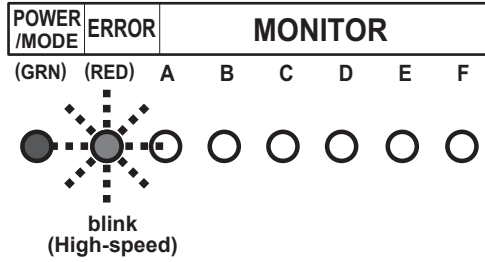

7.2. Error location display

- LEDs A to F of MONITOR light up and display the error location. In the case of an overall error, LEDs A to F of MONITOR do not light up.

Example) Coil error in indoor unit B

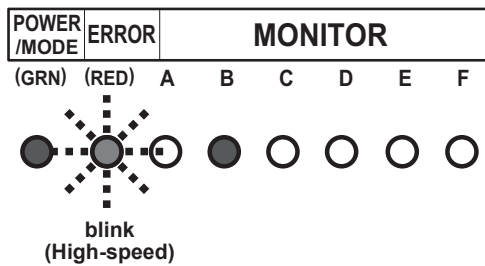

7.3. Error code display

- While the error is occurring, briefly press SW1. The error code is displayed.

Example) Coil error (Error cord = 9A.1)

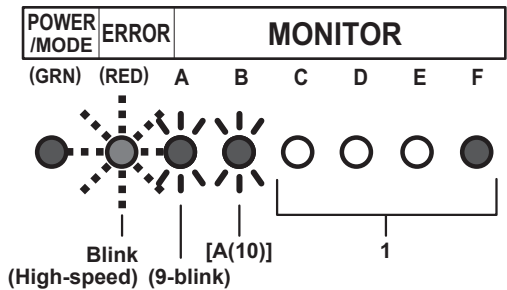

Display mode

LED on: ●

LED off: ○

Blink: (0.5s Light on / 0.5s Light off)

Number of blinking: ()

For MONITOR (A and B)

- A: 10-Blink
- C: 11-Blink
- F: 12-Blink
- J: 13-Blink
- P: 14-Blink
- U: 15-Blink

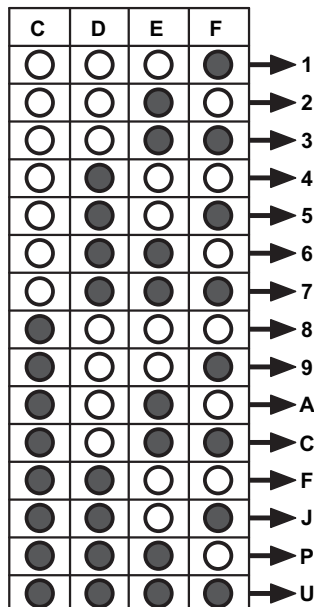

Error code	Error type
11.3	Serial communication error
11.4	Serial communication error during operation
16.5	Communication error between controller and outdoor unit
22.1	Indoor unit capacity error
23.1	Connection forbidden (Series error)
5U.1	Indoor unit error
62.1	PCB model information error
62.3	EEPROM access error
62.8	EEPROM data corruption error
63.1	Inverter error
65.3	IPM error (Trip terminal L error)
71.1	Discharge temp. sensor error
72.1	Compressor temp. sensor error
73.2	Heat ex. middle temp. sensor error
73.3	Heat ex. out temp. sensor error
74.1	Outdoor temp. sensor error
75.1	Suction gas temp. sensor error
76.1	Valve sensor error
76.2	
77.1	Heat sink temp. sensor error
84.1	Current sensor 1 error (stoppage permanently)
86.1	Discharge pressure sensor error
86.4	High pressure switch 1 error
94.1	Trip detection
95.1	Compressor motor control error (stoppage permanently)
97.3	Fan motor 1 error (Duty error)
98.3	Fan motor 2 error (Duty error)
99.1	4-way valve error
9A.1	Coil 1 (expansion valve 1) error
A1.1	Discharge temperature 1 error (stoppage permanently)
A3.1	Compressor 1 temperature error

8. PUMP DOWN

⚠ WARNING

- During the pump down operation, make sure that compressor is off before you remove the refrigerant piping. Do not remove the connection pipe while the compressor is in operation with valve open. This may cause abnormal pressure in the refrigeration cycle that leads to breakage and even injury.

PUMP DOWN OPERATION

When moving or discarding the air conditioner, in order to consider the environment and avoid the discharge of refrigerant to the atmosphere, pump down according to the following procedure.

- Connect the pressure gauge to the charging port.
- Change the DIP switch on the board (SET1-2) to ON*1

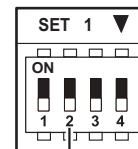

*1: DIP switch (SET1-2)

*Be sure the power supply is disconnected on the breaker is turned off when changing the DIP switch.

- (3) To start operation, press the [PUMP DOWN] switch*2 for 3 seconds or press after the power has been on for 3 min.



*2: Push switch (SW1)

During pump down, the LED (POWER/MODE) will flash 3 times consecutively.

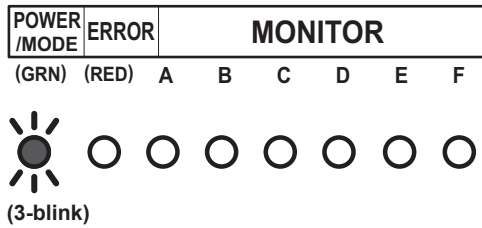

NOTE:

- If the [PUMP DOWN] switch is pressed during compressor operation, the compressor will stop, and the operation will start after about 3 min.
- Close the liquid pipe valve.
- When 7.3 psi ~ 0 psi (0.05 MPa ~ 0 MPa) is shown, close the gas pipe valve.
- Stop pump down by pressing the [PUMP DOWN] switch for 3 seconds. The LED will light as follows.

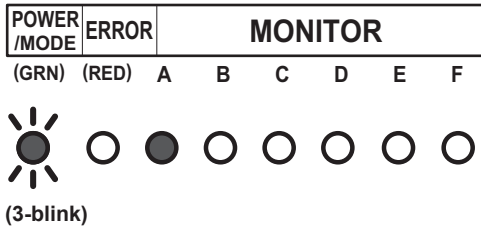

- (7) Disconnect the power supply or turn off the breaker.

NOTES:

- If the pump down is not stopped by pressing the switch as in step (6), it will stop automatically after 15 min. and the LED will light as follows. If the pump down is complete, disconnect the power supply or turn off the breaker. If not completed open the liquid pipe valve, and then start again from step (3).

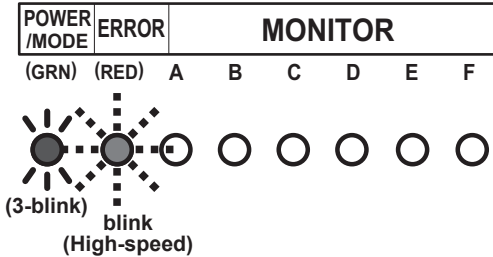

- In order to interrupt the pump down operation, press the [PUMP DOWN] switch again. The LED will return to the original display before starting pump down. (POWER/MODE LED: On)
- The pump down may stop before completion due to error. To complete the pump down, correct the error, open the liquid pipe valve and then start from step (1) again. Otherwise, the refrigerant can be recovered from the service port.

9. FINISHING

9.1. Installing insulation

- Determine the thickness of the insulation material by referring to Table A.

Table A, Selection of insulation

(for using an insulation material with equal heat transmission rate or below 0.040 W/(m·k))

Relative humidity [mm (in.)]	Insulation material				
	Minimum thickness [mm]				
	70% or more	75% or more	80% or more	85% or more	
Pipe diameter	6.35 (1/4)	8	10	13	17
	9.52 (3/8)	9	11	14	18
	12.70 (1/2)	10	12	15	19
	15.88 (5/8)	10	12	16	20
	19.05 (3/4)	10	13	16	21

- If the ambient temperature and relative humidity exceed 32 °C, increase the level of heat insulation for the refrigerant pipes.

10. CUSTOMER GUIDANCE

Explain the following to the customer in accordance with the operation manual:

- Starting and stopping method, operation switching, temperature adjustment, timer, airflow adjustment, and other remote control unit operations.
- Air filter removal and cleaning.
- Give the operation manual and installation instruction sheet to the customer.